



SIMPLE QUIET PORTABLE AFFORDABLE

Your Patients Deserve it All



**Experience the Most Positive Thing to Happen
to Negative Pressure Wound Therapy**



The NEXA System combines the simplicity of disposable NPWT with performance features of traditional durable NPWT technology platforms.

NEXA Indications for Use / Contraindications

The NEXA™ NPWT System is intended for patients who may benefit from the application of negative pressure to the wound to promote wound healing through the removal of excess exudates, infectious material and tissue debris.

It is intended for use in long-term care and acute settings only when prescribed by a Health Care Professional.

Appropriate wound types to include:

- Chronic wounds
- Acute wounds
- Pressure ulcers
- Surgical incision wounds
- Diabetic foot ulcers
- Subacute and dehisced wounds
- Venous leg ulcers
- Partial thickness burns, flaps and grafts



CONTRAINDICATIONS The device is not recommended for treatment of the following conditions:

- Presence of necrotic tissue
- Exposed arteries, veins, nerves, or organs
- Malignancy in wound
- Use over anastomotic sites
- Untreated osteomyelitis
- Non-enteric and unexplored fistulas
- Untreated malnutrition
- Necrotic tissue with eschar

- Patients on anticoagulation medicine or who have active bleeding or who have difficult wound hemostasis should be treated with caution. These patients are at an increased risk for bleeding and bleeding complications and should be treated and monitored by properly trained medical caregivers in a controlled setting.
- Wounds that are in close proximity to blood vessels, organs, muscle, and fascia: All blood vessels, organs, muscles, and fascia that are in close proximity to the wound site and/or are exposed and /or are near the skin surface should be properly protected prior to initiating therapy. Patients with infections in the wound and or other parts of the body have to receive proper systemic treatment.
- Irradiated vessels and tissue. These patients are at an increased risk for bleeding and bleeding complications and should be treated and monitored by properly trained medical caregivers in a controlled setting.
- Bony fragments. Sharp edges from bony fragment may puncture blood vessels, organs, muscles, and fascia and may lead to bleeding. Proper care should be taken to cover the bony fragments and protect the wound area and other areas from bleeding.
- Check wound dressing periodically to ensure there is no buildup of wound fluid or evidence of any bleeding.
- Dressings should be routinely changed every 48 - 72 hours but no less than 3 times a week or when the wound shows signs of infection.
- Do NOT continue using the system if a Hematoma is observed when changing the dressing.

What is the NEXADVANTAGE?

The **NEXA™ Negative Pressure Wound Therapy (NPWT) System** has been developed to provide uncompromising negative pressure therapy for patients with chronic and acute wounds.

SIMPLE:

- **With no complicated interfaces or touchscreens**, the NEXA System features an ultra-simple, one-button operation, requires minimal training and reduces the potential for user error
- **Sleek, streamlined design** with no maintenance required
- **Accurate pressure control is built in**, as the pre-set SmartFlow™ tubing connector constantly regulates negative pressure, preset to -125 mmHg

QUIET:

- Pump runs **smoothly and consistently**
- **No audible notifications** means less “alarm anxiety” for staff, patients and family

Note: alarms are visual only



What is the NEXADVANTAGE?

PORTABLE:

- **Lightweight and small**, ideal for mobile patients
- **Easy to change, compact, lightweight pouch** that collects fluid away from the wound
- **Handy carrying case** for patients on the go
- **Battery lasts 10 hours** before recharging

AFFORDABLE:

- Designed to **operate for 1,344 hours (56 days or 8 weeks)**
- Usable hours are depleted **only when the device is providing therapy**
- Remaining hours can be **used at your convenience on the next patient**
- **Immediate availability** with this off-the-shelf device that requires no tracking and incurs no runaway rental costs
- **Disposable device eliminates servicing** and maintenance costs

Affordable Care means that the patients in need of NPWT can have NPWT. Ask your local rep for the best procurement option for your facility or practice.

A Powerful Balance of SIMPLICITY and PERFORMANCE



This multi-week, multi-patient, disposable system has three innovations that make all the difference.

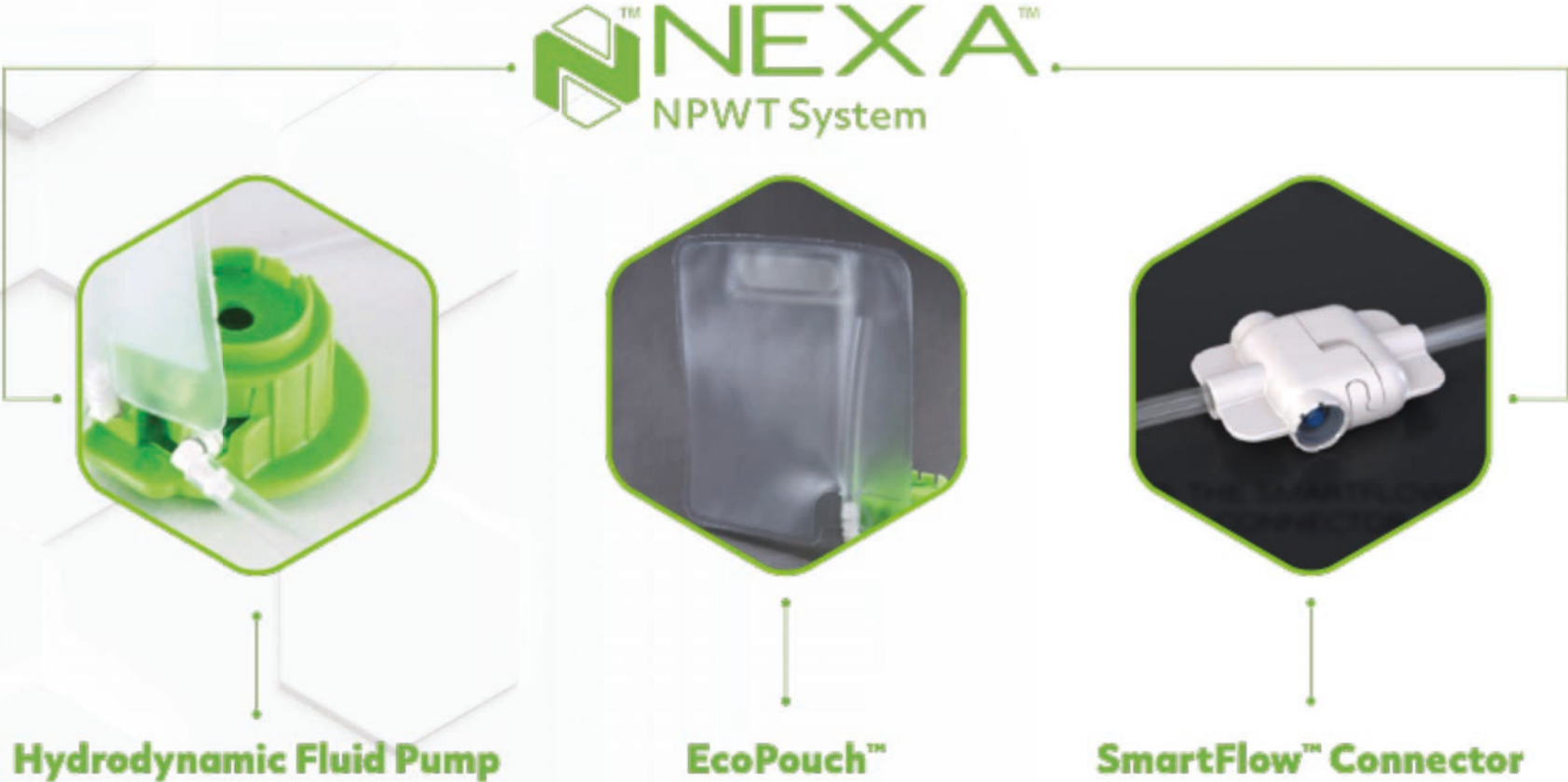

What is the NEXADVANTAGE?



Hydrodynamic Fluid Pump

Continues to remove fluid even in the presence of a minor dressing air leak

- Continuous exudate removal from the wound, reducing potential for skin maceration
- No risk of internal device contamination because the disposable pump never touches the inside of the tubing or fluid container pouch

NEXADVANTAGE When There is a LEAK

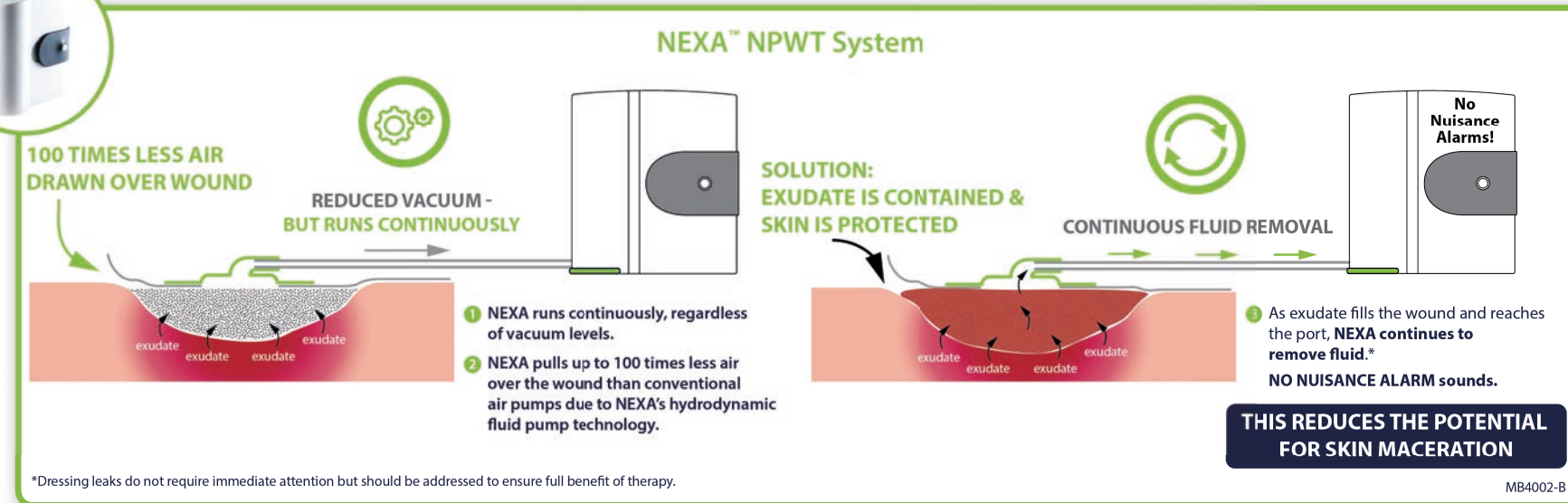
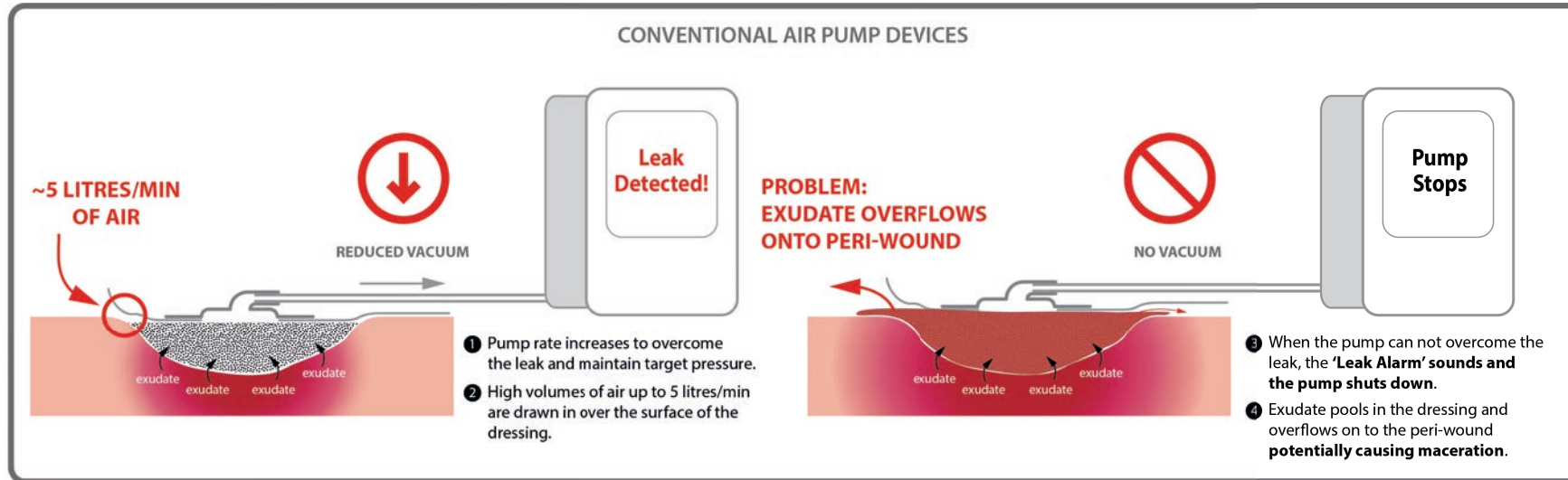

What is the NEXADVANTAGE?



EcoPouch™

Draws exudate away from the wound site into the separate, disposable, flexible pouch

- 120 ml capacity
- Much less shelf space required
- No sterilisation needed
- Requires 58% less polymer content than conventional rigid canisters*

What is the NEXADVANTAGE?



SmartFlow™ Connector

Pressure is constantly maintained at the wound

- Maintains negative pressure levels preset to -125mmHg
- No need for complex pressure monitoring sensors or feedback loops within device, dressing, or tubing

NEXA™ NPWT System – All Components



NEXA Device

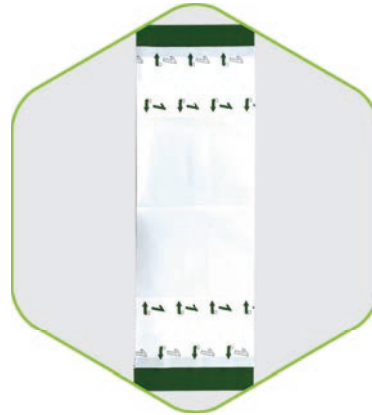

Occlusive Drape

- 32 cm x 13 cm



EcoPouch™ Fluid Container

- 120ml flexible pouch



Reticulated Open Cell Foam
and Tubing Pad



SmartFlow Connector

- Regulates negative pressure at a constant level of -125mmHg

NEXAFFORDABILITY

Smart Choices Add Up.

When you're focused on effective, efficient patient care, the right partner can make a huge difference. NEXA is the affordable NPWT option for your facility.

Here's Why:







- Device will operate for 1,344 hours (56 days or 8 weeks) of total use
 - Hours used are only counted when the unit is powered on
 - After one patient completes therapy, unused hours can be used on subsequent patients
- No need for servicing or maintenance by the manufacturer between patients
- At the end of 1,344 hours total use, the device can be disposed of or returned to AOTI



*For device only. Additional costs for dressings and EcoPouch™ containers will vary depending on the number required for each patient.



Disposable NPWT Comparison

		AOTI NEXA System	3M SNAP	Molnlycke Avance Solo	Medela Invia Motion	S&N Pico	ConvaTec Avelle	Genadyne Uno
								
CLINICAL	Intended Use	Wounds	Wounds	Incisions & Wounds	Incisions & Wounds	Incisions & Wounds	Incisions & Wounds	Incisions & Wounds
	Wound Severity	Low	Low	Low	Low	Low	Low	Low
	Pressure (mmHg)	-75, -125	-75, -100, -125	-125	-60, -80, -100, -125, -150, -175	-80	-80	-80, -125
TECHNICAL	Fluid Storage / (capacity)	Flexible Pouch (120ml)	Internal Cartridge (60ml & 150ml)	Absorbent Dressing & Rigid Canister (50ml)	Rigid Canister (150ml)	Absorbent Dressing	Absorbent Dressing	Absorbent Dressing
	Dressing Seal	Polyurethane Acrylic	Hydrocolloid	Silicone / Absorbent	Polyurethane Acrylic	Silicone / Absorbent	Silicone / Absorbent	Silicone / Absorbent
	Hydrodynamic Fluid Pump	Continues working w/minor dressing leaks	No	No	No	No	No	No
	Wound filler	Foam	Foam	Foam	Foam / Gauze	N/A	N/A	N/A
	Portability	0.9 lbs	0.2 lbs	.29 lbs	.88 lbs	0.2 lbs	0.2 lbs	0.9 lbs
	Alarms	Visible (Audible option coming)	Visible	Visible and Audible	Visible and Audible	Visible	Visible	Visible / Audible
ECONOMIC	Device Life	56 days	Up to 7 days	14 days	15 or 60 days	7 or 14 days	7 days	15 days
	Multi-patient Use	Yes	No	No	No	No	No	No

Why NEXA System?

- ◆ The NEXA System combines the simplicity of disposable NPWT with performance features of traditional durable NPWT technology platforms.
- ◆ The NEXA System is ideal for an acute care facility to have an off-the-shelf product for immediate use that can go with the patient when being discharged to another level of care for more efficient transitions.
- ◆ The NEXA System is ideal for an extended care facility where high performance and lower cost are essential for optimal patient care.
- ◆ When only needed for short periods of time, the NEXA System can be used on multiple patients during the total device life of 8 weeks.





NEXA System Application and Operation

Charging the NEXA System

Fully charge the NEXA Device.

Charging takes approximately 4 hours.

Insert the NEXA Device charger into the socket. If the NEXA Device is off, press the ON button and the charging light will flash.

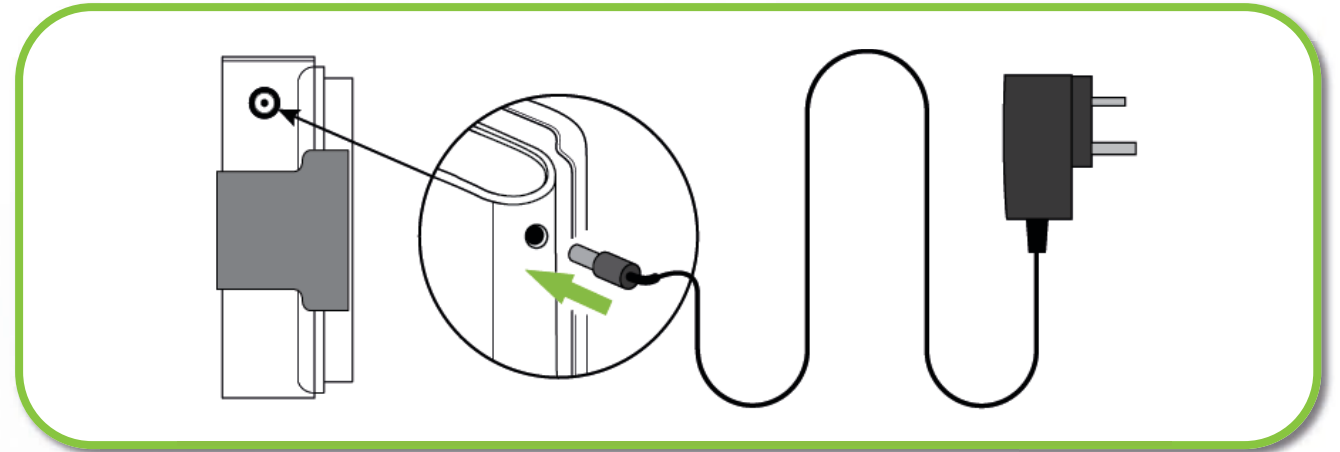

Battery is CHARGING when the orange light flashes.

The device has a sleep mode. If the charging light is not flashing, turn the device on and off again to wake it.

The device may be used while charging.

The device will operate on battery only for approximately 10 hours.

The orange light will illuminate and remain lit when the battery has 2 hours of run time remaining.

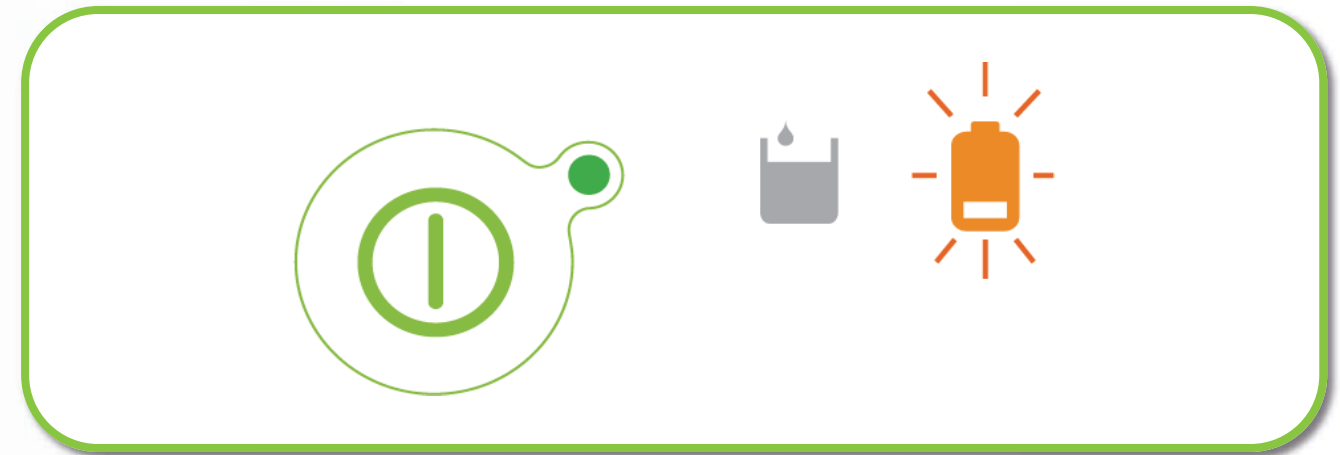



Dressing Application

Note:

- Always ensure the device is switched off when connecting the dressing.
- Select the appropriate dressing pressure value, -75mmHg OR -125mmHg, as clearly labeled on the packaging.
- Dressings should be changed every 48-72 hours but no less than 3 times per week. Not to be re-sterilised or re-used.

1. 
Clean the wound and prepare the surrounding skin.

2. 
Cut the foam to suit the wound size. Do not cut over the wound.

3. 
Place the foam into the wound, ensuring it does not overlap on to healthy skin as there is a risk of allergic reaction

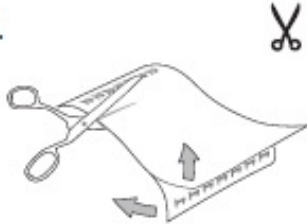
4. 
Trim the drape to overlap the wound and foam by approximately 2 cm. Remove layer 1.

5. 
Apply the drape to the skin and press down edges firmly. Remove layer 2.

6. 
Pinch the drape over the foam and cut a 1cm hole.

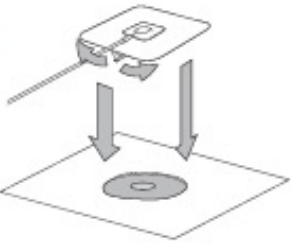
7. 
Peel off the pad film backing layer and apply to the drape, aligning hole with the pad.

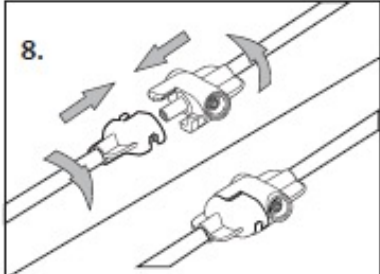
8. 
Connect dressing to the Fluid Container Pack. Push connector together and twist to lock.

Setting up the NEXA System

1. Remove NEXA Device from carrying case
2. Open gray cover and insert Fluid Container Pack
 - Insert in orientation shown. Push firmly until it clicks.

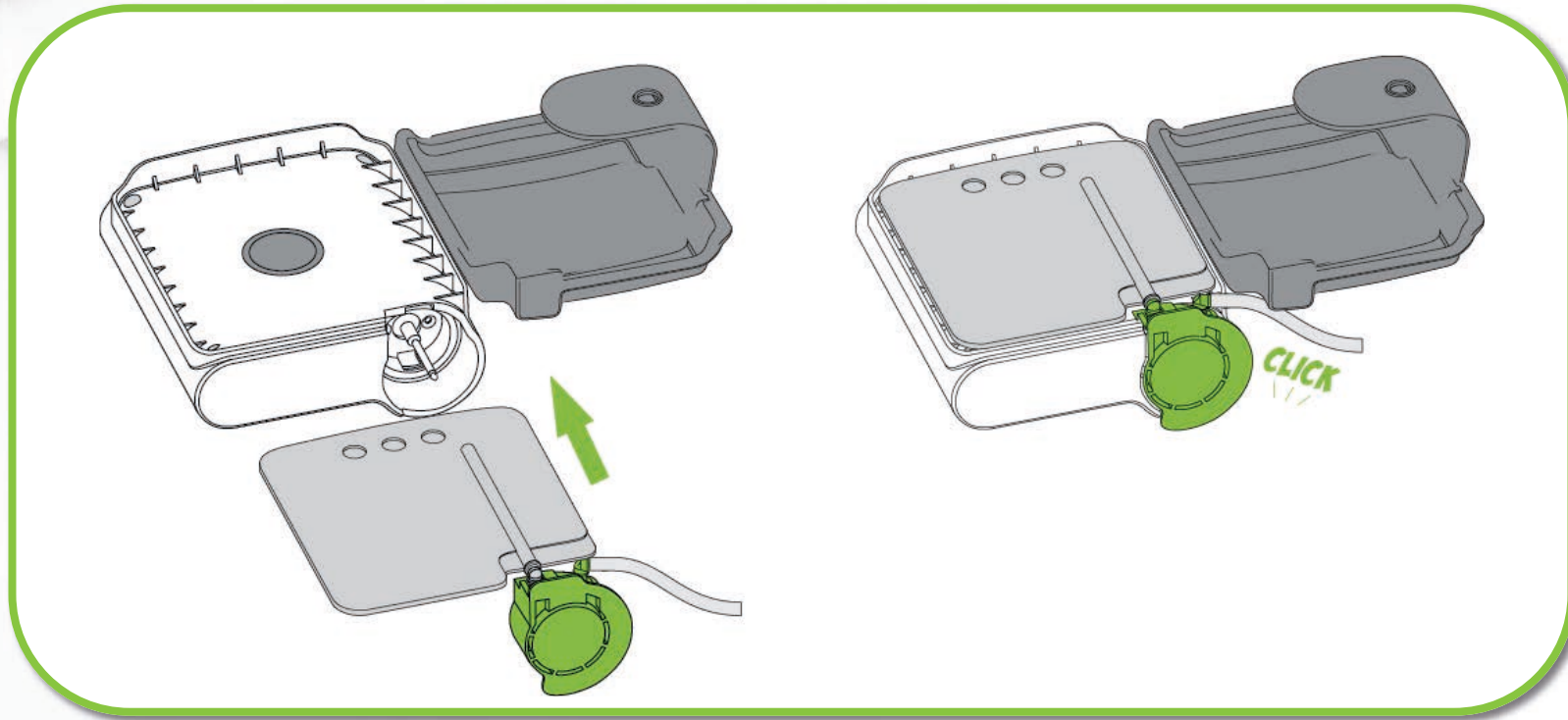

Setting up the NEXA System

3. Close gray cover and latch the strap to the case.

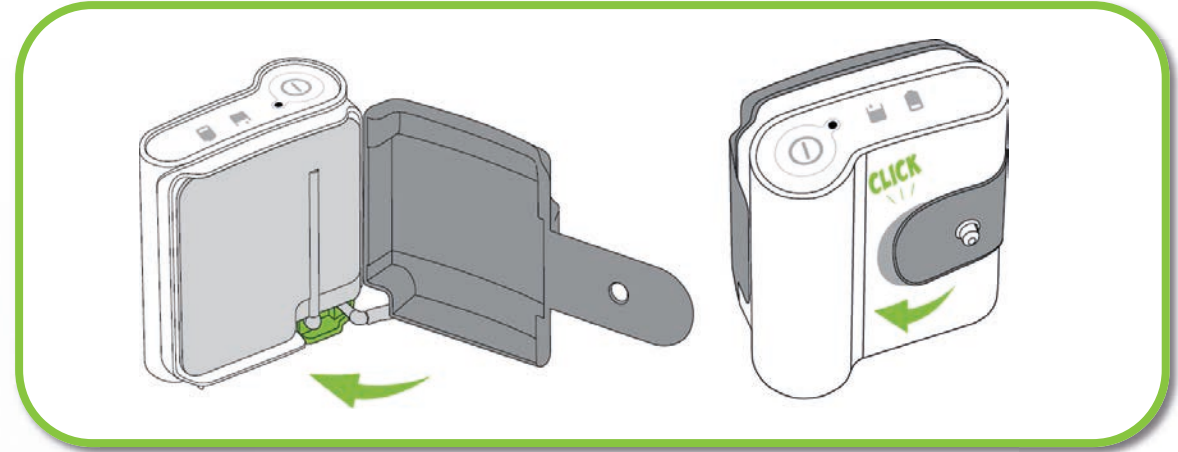

4. Place the carrying case upright and place the device inside as shown. Then zip it closed with the tube exiting.

Keep upright using the straps to attach to a bed frame or other furniture.

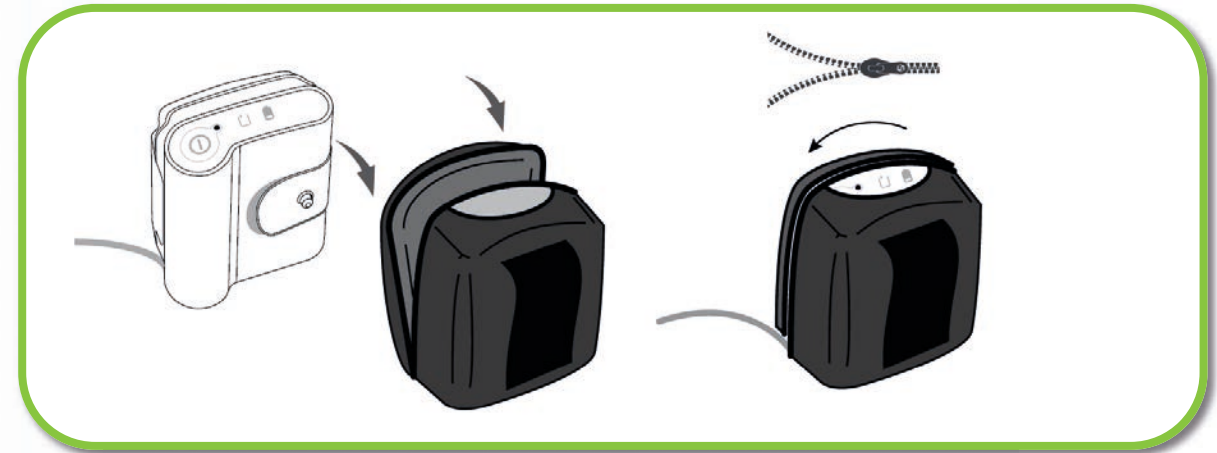

Setting up the NEXA System

5. Connect the dressing to the EcoPouch™ fluid container.

6. Position the NEXA Device for use

- For best performance and to enable the maximum fluid containment of 120ml, use the NEXA System UPRIGHT, even in the carrying case.
- Use the buckles and straps to attach to a bed rail or headboard.

7. Press the ON/OFF button to start the device.

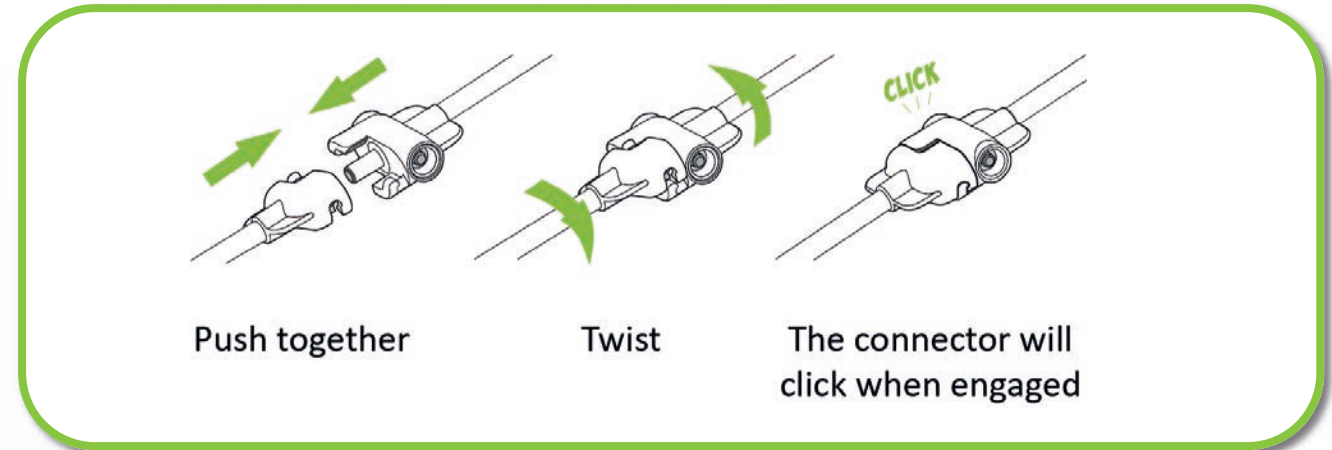

Days Remaining Feature

Open the gray cover, press and hold the gray button while pressing and holding the power button for 8 seconds. The red light will indicate the number of 10-day increments and the orange light will indicate the 1-day increments. (i.e. 4 red flashes and 2 orange flashes = 42 days remaining)

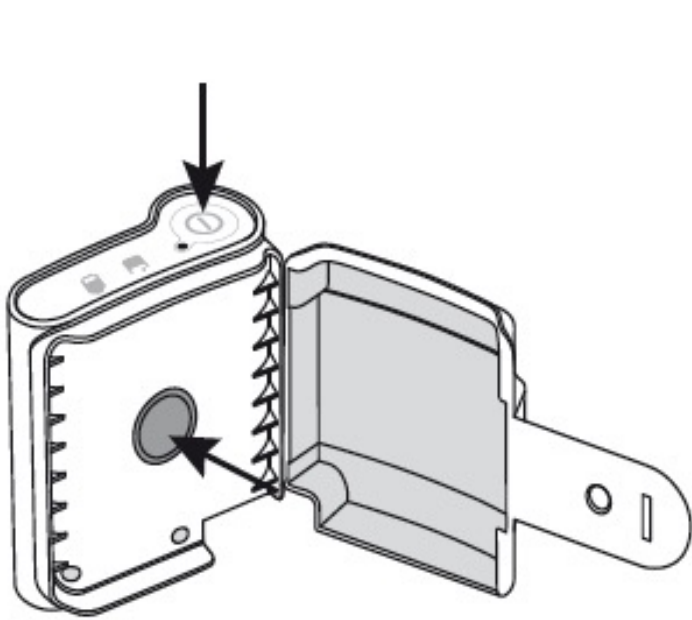

The **RED** LED is the canister full alert (10 days remaining)



ORANGE LED is the battery low alert (1 day remaining)



NEXATM
NPWT System

Sold and distributed by:



**SIMPLE
QUIET
PORTABLE
AFFORDABLE**